

OHS

ONLINE HOME SHOP

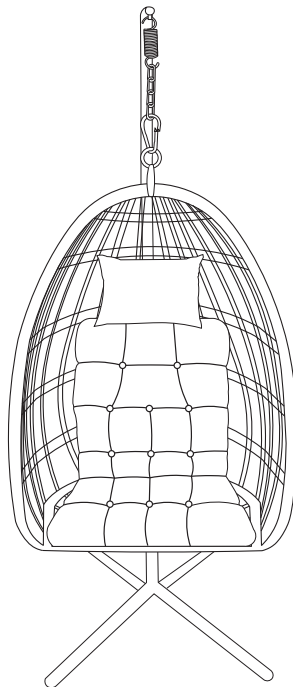







Hanging Egg Chair Assembly & Fitting Guide

MAX CAPACITY 100KG

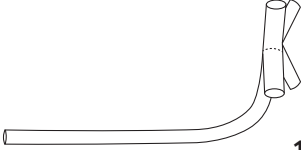
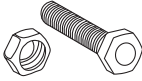
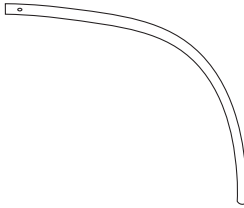
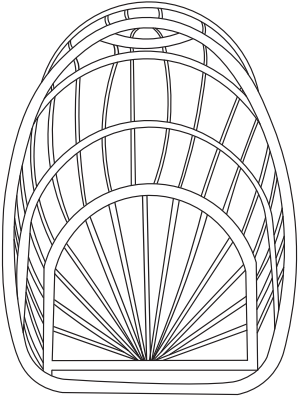

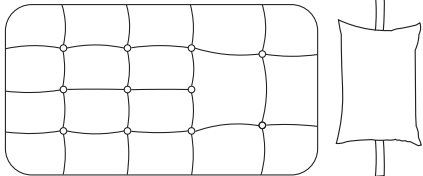
SKU:

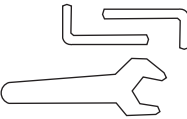
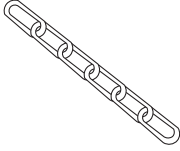
GA000095|GA000096|

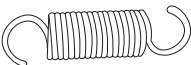
<p>A</p>  <p>4 PC</p>	<p>H</p>  <p>1 PC</p>
<p>B</p>  <p>1 PC</p>	<p>I</p>  <p>1 PC</p>
<p>C</p>  <p>1 PC</p>	<p>J</p>  <p>1 PC</p>
<p>D</p>  <p>4 PC</p>	<p>K</p>  <p>1 PC</p>
<p>E</p>  <p>1 PC</p>	<p>L</p>  <p>3 PC</p>
<p>F</p>  <p>1 PC</p>	<p>M</p>  <p>1 PC</p>
<p>G</p>  <p>1 PC</p>	

1 COMPILE ALL THE COMPONENTS

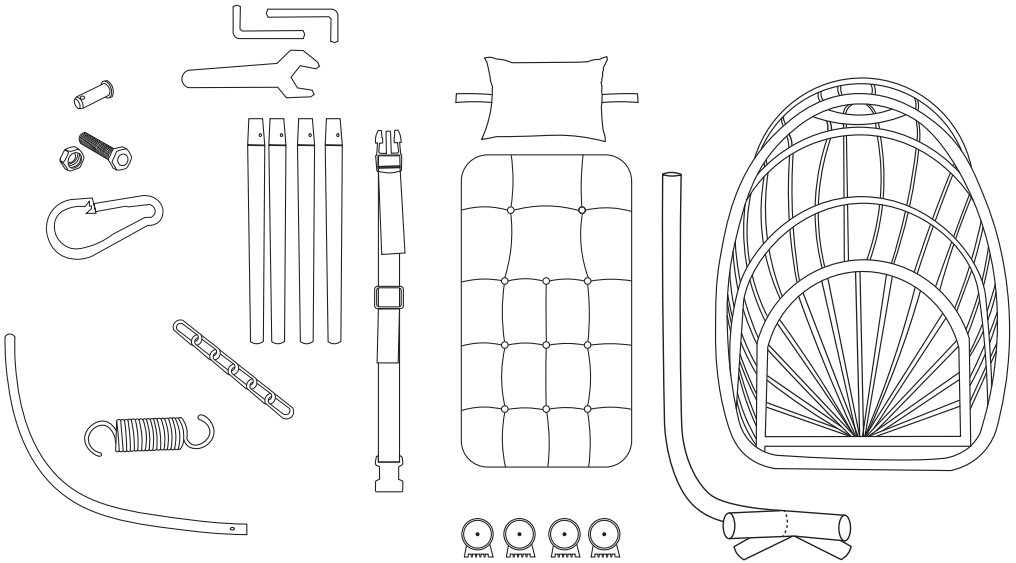

2 ATTACH THE LEGS (A) TO THE BASE (B) BY ALIGNING EACH LEG UP WITH THE BASE OPENINGS, PRESS SPRING BUTTON AND ENSURE IT POPS THROUGH ON EACH ALLOCATED HOLE TO SECURE LEGS CORRECTLY

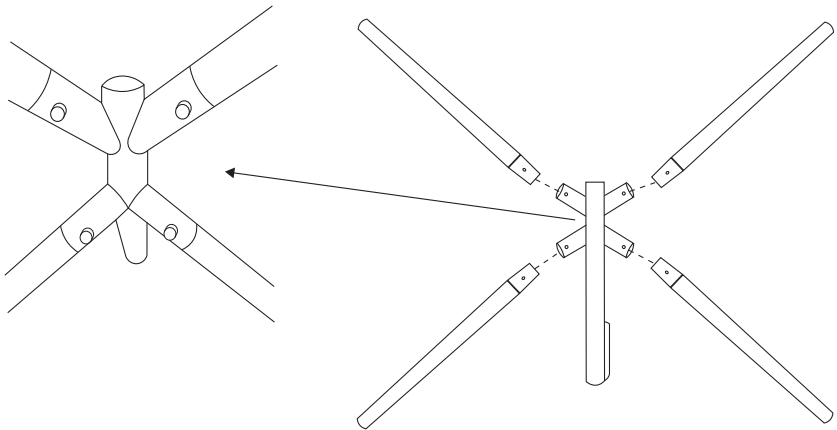

3 ADD THE FEET (D) TO EACH LEG

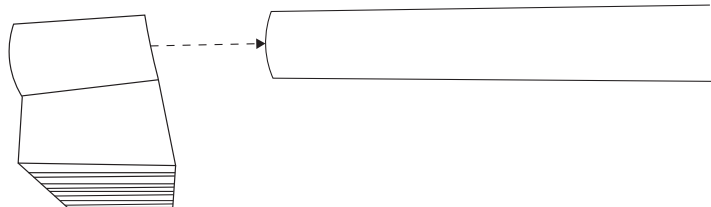

4 ATTACH THE TOP SUPPORTING BAR (C) TO THE BASE AND SECURE WITH THE SCREW AND NUT (I)

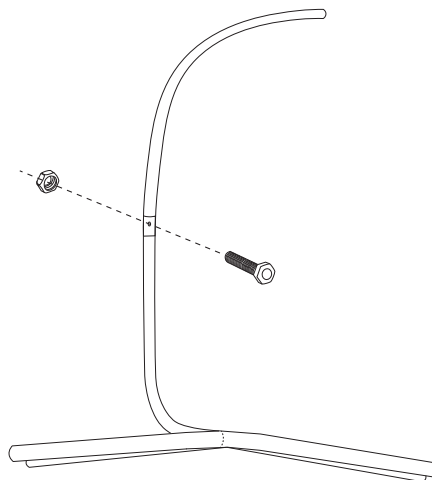

5 ADD THE PIN (M) TO THE TOP BAR



6 CONNECT THE SPRING (G), CHAIN (F) AND CARABINER HOOK (E)

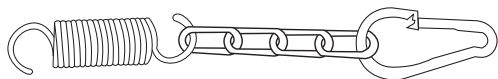

7 ATTACH THE CARABINER HOOK TO THE LOOP AT THE TOP OF THE CHAIR BASKET (J)

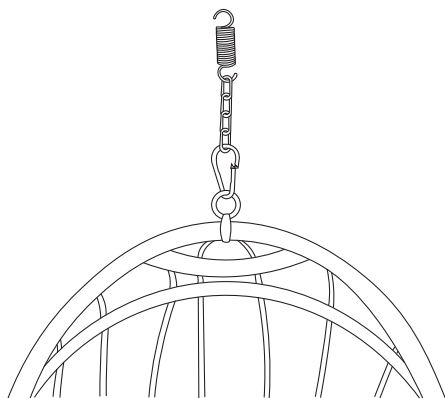

8 ATTACH THE CHAIR TO THE BASE

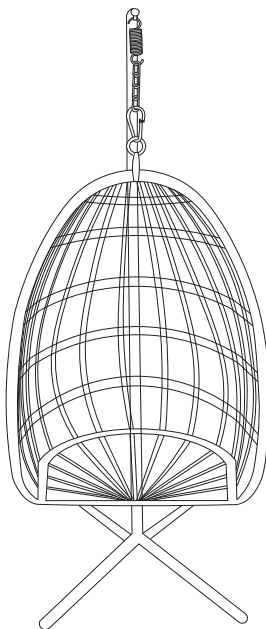

9 SECURE THE CHAIR TO THE BASE USING THE SAFETY STRAP (H)

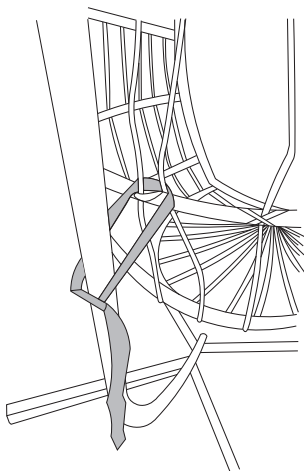

10 COMPLETE BY ADDING THE CUSHIONS (K)

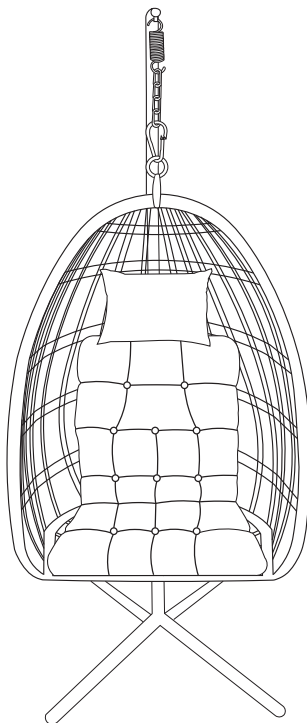

OHS

ONLINE HOME SHOP

For any product support please
contact our Customer Service team:
support@onlinehomeshop.com

Made in China

Online Home Shop LTD Priestley Road, Manchester, M28 2LX, UK